

Electronic heat cost allocators

WHE5../WHE6..



Electronic device for heat cost allocation based on measuring the heat output from radiators.

- With radio interface for remote read out or optical interface for on-site read out without communication
- Available as a two-sensor device or with remote sensor
- Parallel transmission of AMR and walk-by telegrams
- Communication in S-mode or C-mode
- OMS compliant AMR telegrams in C-mode

Application

The electronic heat cost allocators WHE5.. and WHE6.. are designed for decentralized installation and used when heating costs must be allocated to several consumers based on actual consumption. Temperatures are acquired by one (radiator) or two sensors (radiator and room temperature sensor). In two-sensor mode, the actual temperature difference between room temperature and radiator temperature is acquired, while in one sensor mode, a constant value for the room temperature is predefined.

These measured values are used as the basis for calculating consumption. The main areas of application are in central heating systems, where heating energy is used individually by the different consumers.

The WHE5../WHE6.. can be operated as a one- or two-sensor measuring system with product or unit scale.

Such systems are used in e.g.:

- Multi-family homes
- Office and administrative building

Typical users:

- Service and billing providers
- Housing industry and housing cooperatives
- Building service companies and real estate agencies

The heat cost allocator is used together with the following types of radiators:

- Ribbed radiators
- Tubular radiators
- Panel-type radiators with horizontal or vertical water flow
- Radiators with internal tube register
- Convector and bathroom radiators

Compatibility

The WHE54.. and WHE63.. replaces the WHE55.. and WHE56.. In addition to improved energy management, the WHE54.. and WHE63.. can be operated in different RF modes and are compatible with the WHE55.., WHE56.. as well as WHE3.. and WHE4... The existing heat conductors of the WHE3.. and WHE4.. device families can be reused with the WHE5... and WHE6.. The non-communicating WHE50.. (B-series) is compatible with the WHE3.. and WHE50.. (A-series).

NOTICE



The WHE2.. cannot be replaced by the WHE5.. or WHE6.., since neither the measuring algorithm nor RF transmitter fitted in the heat cost allocator (with WHE26) are compatible.

One- and two-sensor measuring system

The joint use of different device types in one and the same property is only permitted as long as the devices use the same standard measuring system and have a standard measuring algorithm.

Two-sensor heat cost allocators can be operated unconfigured and as often as you want in a one-sensor heat cost allocator.

Limitations

Electronic heat cost allocators cannot be used in connection with steam heaters, fresh-air radiators, floor heating systems, ceiling heating elements or flap-controlled radiators.

For combined valves and flap-controlled radiators, measuring devices may only be installed if the flap control unit is removed or disabled in the "open" position.

The electronic system must be removed or disabled on convectors where an electric fan varies output or towel heaters with an electric heating cartridge, to install electronic heat cost allocators.

Functions

The heat cost allocators are classified as follows based on type of communication:

- No communication interface
- With optical communication interface (optional)
- With RF interface

No communication interface

Heat cost allocators without communication interface WHE50.. must be read visually on site and the measuring results must be manually recorded. They are especially suited for systems that do not require complex data evaluations or particularly fast readout processes.

With optical communication interface

The heat cost allocator with optical communication interface can be read on site using an infrared adapter and a suitable computer and the data can be archived for later evaluation.

With RF interface

Wireless heat cost allocators send parallel AMR and walk-by data telegrams in S-mode or C-mode. AMR telegrams comply with OMS in C-mode.

Walk-by

The heat cost allocators are read locally via radio. They transmit consumption data at the set reading time. The reads collect the RF telegrams using a mobile readout tool ¹⁾. The meter-reader does not have to enter the user's residence or office.

In the case of smaller plants, the data can usually be collected from outside the building.

AMR

Heat cost allocators transmit the current consumption data in cycles to network nodes. They automatically collect the data of all integrated heat cost allocators and store them. The customer can remotely read out all plant consumption data.

Readout parameters

The heat cost allocators transmit the following parameters via RF:

- Device number (8 digits)
- Type of device/software version version
- Time of day/date
- Error status
- Error date
- Current consumption
- Due date
- Due date value
- Counter reading at end of last month
- 13 monthly values (only for walk-by)

¹⁾ In development: Mobile readout tool WTT726-FE7300 and Readout and parameterization app ACT60

Tampering

Heat cost allocators are equipped with a factory installed lead seal.

Any unauthorized device opening is registered, shown on the display (WHE50..) and transmitted via radio (WHE5.. / WHE6..).















Function check

Heat cost allocators perform a self-test every 4 minutes. An error message "Err x" is displayed if the error lasts for 5 consecutive measuring cycles (20 minutes).

After the error has been registered and shown on the display, the device stops measuring. The date the error occurred is stored internally.

Display device type

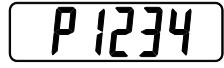
Device states, consumption values and measuring system information are displayed in a loop.

Display loops in normal mode		
		
Current consumption		2 s
		
Display test: Everything on		0.5 s
		
Display test: Everything off		0.5 s
		
Due date For example, December 31		2 s
		
Due date value		5 s
		
Checksum		2 s
		
<i>These displays steps are only visible if a product scale is added to the WHE5..:</i>		
<i>kQ value corresponds to the radiator rated capacity in W</i>		1 s
		













<i>kC value</i> <i>Evaluation factor that considers the thermal coupling of the temperature sensor</i>		1 s
Variable display		1 s See "Overview variable displays"

Sleep mode

Devices are factory set to sleep mode. Measuring operation inactive.

Display loop sleep mode		
Sleep mode Measuring operation inactive		2 s
Due date For example, December 31		2 s
Variable display		2 s See "Overview variable displays"
	FS = Code for walk-by and AMR (S-mode) FC = Code for walk-by and AMR (C-mode) AL = Algorithm, no RF system available	
	3 = Code for WHE3x algorithm 4 = Code for WHE4x algorithm	
	1 = Code for one-sensor measuring system 2 = code for two-sensor measuring system	

Special displays

Error messages			
"Err 1" appears constantly. All other error messages are displayed in quick succession alternating with consumption values.		0.5 s	
Consumption display suppressed			
Is displayed in the event of an error in place of invalid consumption values based on the setting.		0.5 s	
End of battery life			
Is displayed after the end of service life, alternating with the consumption values based on the setting.		0.5 s	
Tampering or housing opening			
Is displayed in the event of tampering either as clear text, alternating with the consumption values, or by the indicator "c" shown discretely on all displays based on the setting.	 Clear text	0.5 s	
Example: Display "current value" with "c".	 Discrete	0.5 s	
Data interface (IrDA close range interface)			
This display indicates an active close-range interface.		10 s	
Radio system activated (AMR/walk-by) S-mode: Walk-by and AMR C-mode: Walk-by and AMR			
The transmission of installation telegrams is indicated on this display. Display sequence: InSt8, InSt7, ... InSt1		30 s	
Commissioning			
This display appears after snapping the device onto the mounting plate. The display then changes to the normal mode display loop.		3 s	
Remote sensor identification			
The meter has detected a remote sensor and adjusts its measuring behavior accordingly.		3 s	

Measuring principle

Heat cost allocators are delivered as a one- or two-sensor devices. The following valuation factors are set when the units are delivered:			
$K_{CHF} = 1.28$	$K_c = 2.50$	$K_Q = 1000$	Exp. = 1.15
If the heat cost allocator does not work with a product scale, the consumption value (VW) must be calculated before billing, based on the readout value (AW) and the radiator-specific K-values (K_c , K_{CHF} and K_Q).			
One-sensor device	$VW = 7.529 * 10^{-4} * AW * K_Q * K_{CHF}^{1.15}$		
Two-sensor device	$VW = 3.486 * 10^{-4} * AW * K_Q * K_c^{1.15}$		
The respective K_c values can be determined by using the K_c value database.			

Default parameters

The following parameters are factory set:	
Zeroing after the due date	Yes
Counting progress even after a device opening was identified	
Opening display as clear text	Yes
Conversion of the consumption values is not performed if the device parameters are changed	
Settings:	
Sensing type	From a two to one-sensor measuring system
K_c/K_Q	Valuation factors for calculating the heat output of a radiator (depending on the device's algorithm and the sensor type)
Next due date	Day the annual value is stored
Device name/device password	Device access data to prevent unauthorized device access
RF mode	S-mode or C-mode (depending on the variant)

Special functions

Continuous counting (without zeroing)
The meter status is not "zeroed" at the due date, but continues to count like a roller type counter. This option is set by default to "No" (counter reading will be reset to "0" at the due date)
Display battery warning
The heat cost allocator features service life monitoring. An optical message "bat00" displays if the battery service life has expired

Display meter readings in case of errors

The units accumulated until the heat cost allocator fails displays on the heat cost allocator as a counter reading.

The option is set by default to "No", i.e. the consumption values are no longer displayed as soon as an error is registered. You can read, however, to determine whether to use the values (or not)

Opening display as clear text

An identified device opening is displayed as "c OPEn", alternating with the current value or the value of the previous year (old value) as a clear text message on the display of the heat cost allocator.

If this option is set to "No", a device opening can be identified by the display of the icon "c" on all displays (discrete display)

Summer switch-off

Summer switch-off is activated by setting a date for the start and the end of summer switch-off. If active, the heat cost allocator records no consumption values during this period of time

RF features in S-mode

Features of the heat cost allocators in S-mode:		
RF system	Parallel transmission of data telegrams	<ul style="list-style-type: none">• AMR• Walk-by
Transmission delay (Offset)	<ul style="list-style-type: none">• Time delay for sending out telegrams after the due date• Time delay for sending out telegrams after the start of the month in days (Default = 0 days)	
Transmission-free days	A maximum of 2 weekdays – selected from Friday, Saturday and Sunday – can be defined as transmission-free days. At least 1 day of the week must be set (default = Sunday)	
Transmission response		
AMR telegrams	Every 4 hours, 24 hours a day, 365 days a year Data and monthly telegrams with consumption values	
Walk-by telegrams	Every 128 seconds, 10 hours a day (from 8:00 am to 6:00 pm)	
	Readout type	Monthly: 4 reading days from the first of each month Annually: 48 reading days, once a year by due date
	Transmission-free days	Monthly: Saturday and Sunday Annually: Sunday
Current consumption values and 13 statistical values		

RF features in C-mode

Features of the heat cost allocators in C-mode:		
RF system	Parallel transmission of data telegrams	<ul style="list-style-type: none"> • AMR • Walk-by
	Increased radio power (10 dBm)	
Transmission response		
AMR telegrams	Every 7.5 hours, 24 hours a day, 365 days a year Data telegrams with consumption values	
Walk-by telegrams	Every 112 seconds, 10 hours a day (from 8:00 am to 6:00 pm) 365 days a year Current consumption values and 13 statistical values	

Change of mode

You can change from S-mode to C-mode at any time with the ACT50-HCA ¹⁾ (V2.1 or higher), the infrared reading head WFZ.IRDA-USB ²⁾ and the programming adapter HCAPH001 001.

¹⁾ To be replaced by ACT60 (in development)

²⁾ To be replaced by WTT726-FE7300 (in development)

Type summary

The following types of heat cost allocators are available:

WHE.. with RF interface (AMR + walk-by), S-mode

Options	Order number	Type
Two-sensor device, battery warning On summer switch-off between 06/01 and 08/31, due date 12/31 Walk-by reading mode: Annually, S-mode	S55562-F127	WHE542-D100S
Two-sensor device, battery warning On summer switch-off between 6/01 and 9/30, due date 9/30 Walk-by reading mode: Monthly, S-mode	S55562-F128	WHE542-D291S

WHE.. with RF interface (AMR + walk-by), C-mode

Options	Order number	Type
Two-sensor device, battery warning On summer switch-off between 6/01 and 9/30, due date 9/30 C-mode	S55562-F129	WHE632-D292C

Delivery

Heat cost allocators are delivered in packages of 50 units (1 packaging unit).



Heat cost allocators are delivered without instructions and without heat conductor.

Accessories

Fittings

Component	Order number	Type
Threaded hoop (pipe 18 to 30 mm)	JXF:FKT0014	FKT0014
Threaded hoop (pipe to 17 mm)	JXF:FKT0004	FKT0004
Shank nut M3 x 3	JXF:FNM0002	FNM0002
Shank nut M3 x 6	JXF:FNM0003	FNM0003
Shank nut M3 x 9.5	JXF:FNM0001	FNM0001
Clamping sleeve special radiator	JXF:FKM0002	FKM0002
Clamping bracket (pipes TE 36 mm)	JXF:FKT0015	FKT0015
Clamping bracket (pipes TE 46 mm)	JXF:FKT0016	FKT0016
Clamping bracket shortened	JXF:FKT0009	FKT0009
Clamping bracket trapezoidal 35 mm	JXF:FKT0018	FKT0018
Clamping bracket trapezoidal 50 mm	JXF:FKT0019	FKT0019
Clamping bracket trapezoidal 65 mm	JXF:FKT0020	FKT0020
Expanding bracket for lamella-type radiator	JXF:FKA0004	FKA0004

Component	Order number	Type
Square bolt 4.5 mm with cross pin	JXF:BOZ4002	BOZ4002
Square bolt 6 mm with cross pin	JXF:BOZ4003	BOZ4003
Square bolt 12 mm with cross pin	JXF:BOZ4004	BOZ4004

Installation parts

Component	Order number	Type
Spacer sleeve	JXF:FKT0010	FKT0010
Spacer	JXF:FKA0013	FKA0013
Threaded bushing	JXF:FKA0012	FKA0012
Clamping piece (threaded hoop 17 mm)	JXF:FKA0003	FKA0003
Clamping piece (threaded hoop 18. 30 mm)	JXF:FKA0008	FKA0008
Installation plate for remote sensor	JXF:FKA0009	FKA0009
Mounting plate standard	S55563-F115	FKA0017
Mounting plate wide	JXF:FKA0022	FKA0022
Prism	JXF:FKA0001	FKA0001
Wall adapter	JXF:FKK0044	FKK0044
Contact screw	JXF:FKA0010	FKA0010
Contact screw long	JXF:FKA0011	FKA0011

Standard parts

Component	Order number	Type
Self-tapping screw B 2.9 x 13	JXF:FNR0008	FNR0008
Screw B 3.9 x 45	JXF:FNR0007	FNR0007
Phillips-head screw M4 x 30	JXF:FNR0003	FNR0003
Phillips-head screw M4 x 40	JXF:FNR0004	FNR0004
Phillips-head screw M4 x 50	JXF:FNR0005	FNR0005
Phillips-head screw M4 x 70	JXF:FNR0006	FNR0006

Component	Order number	Type
Welding stud M3 x 8	JXF:FKT0013	FKT0013
Welding stud M3 x 12	JXF:FKT0011	FKT0011
Welding stud M3 x 15	JXF:FKT0012	FKT0012
Hexagon nut M4	JXF:FNM0004	FNM0004
Self-locking nut with serrated bearing M3	JXF:FNM0005	FNM0005

Other accessories

Component	Order number	Type
Dowel 6 mm	JXF:FNU0001	FNU0001
Remote sensor set 1.5 m	JXF:HCAIK010 0S1	HCAIK0100S1
Remote sensor set 2.5 m	JXF:HCAIK010 0S2	HCAIK0100S2
Remote sensor set 5.0 m	JXF:HCAIK010 0S5	HCAIK0100S5
Lead seal blue	JXF:FKK0041	FKK0041
Cable duct white	JXF:FOZ0001	FOZ0001
Snap-on panel	JXF:FKK0034	FKK0034
Installation template	JXF:HCAIP001001	HCAIP001001
ERGO universal instant glue 3g	JXF:FSS0007	FSS0007
Installation aid (convector)	JXF:FKT0017	FKT0017

Programming and readout accessories

Component	Order number	Type
Readout and parameterization software	JXF:ACT50-HCA	ACT50-HCA ¹⁾
Programming adapter	JXF:HCAPH001001	HCAPH001001
Infrared read head with USB interface	JXF:WFZ.IRDA-USB	WFZ.IRDA-USB
Mobile tool (ACT60)	S55563-F161	WTT726-FE7300
PC RF module (only S-mode telegrams)	JXF:WTZ.RM	WTZ.RM

¹⁾ To be replaced by ACT60 (in development)

Product documentation

System manual

The System Manual is available in the following languages:	
German	CE2M2886de
English	CE2M2886en
Italian	CE2M2886it

Related documents such as the environmental declarations, declarations of conformity, etc., can be downloaded from the following Internet address:

www.siemens.com/bt/download

Notes

Engineering

- Heat cost allocators are designed for wall mounting
- Install the device in accordance with the System Manual
- Observe all permissible ambient conditions
- Do not expose heat cost allocators to dripping water

NOTICE



For information about project planning and installation, please refer to the System Manual.

Mounting

Attach a heat cost allocator to each radiator with the appropriate mounting materials (listed under mounting material).

Maintenance

The devices are maintenance-free.

Disposal



This symbol or any other national label indicate that the product, its packaging, and, where applicable, any batteries may not be disposed of as domestic waste. Delete all personal data and dispose of the item(s) at separate collection and recycling facilities in accordance with local and national legislation.

See www.siemens.com/bt/disposal for additional information.

Warranty service

Comply with all technical data relating to the application. Siemens rejects any and all warranties in the event that third-party products are used.

Power supply	
Battery type	3 V lithium battery
Battery life	Type 10 years

Functional data	
RF:	
Radio frequency	
<ul style="list-style-type: none"> S-mode C-mode 	(868.30 +/- 0.30 MHz) (868.95 +/- 0.25 MHz)
Transmitting power:	
<ul style="list-style-type: none"> S-mode C-mode 	Typical 2.5 dBm, max. 14.0 dBm Typical 7.3 dBm, max. 14.0 dBm
RF protocol	Wireless M-bus per EN 13757-4
Measuring principle:	
One- or two-sensor devices	
Field of application ¹⁾ :	
<ul style="list-style-type: none"> One-sensor WHE3x algorithm One-sensor WHE4x algorithm 	$t_{min,m} = 55^{\circ}\text{C}$, $t_{max,m} = 105^{\circ}\text{C}$ $t_{min,m} = 55^{\circ}\text{C}$, $t_{max,m} = 105^{\circ}\text{C}$
<ul style="list-style-type: none"> Two-sensor WHE3x algorithm <ul style="list-style-type: none"> Standard scale: Scaled: Two-sensor WHE4x algorithm 	$t_{min,m} = 48^{\circ}\text{C}$, $t_{max,m} = 105^{\circ}\text{C}$ $t_{min,m} = 35^{\circ}\text{C}$, $t_{max,m} = 105^{\circ}\text{C}$ $t_{min,m} = 35^{\circ}\text{C}$, $t_{max,m} = 105^{\circ}\text{C}$
Start of metering: (t_z refers to the temperature of heating medium determined)	
<ul style="list-style-type: none"> One-sensor devices 	$t_z \geq 30^{\circ}\text{C}$ (at $t_L = 20^{\circ}\text{C}$) unevaluated $t_z \geq 28^{\circ}\text{C}$ (at $t_L = 20^{\circ}\text{C}$) evaluated
<ul style="list-style-type: none"> Two-sensor devices 	$t_z - t_L \geq 5\text{ K}$
¹⁾ Definitions according to DIN EN 834: $t_{min,m}$: Lowest mean design heating medium temperature at which the heat cost allocator may be used. With single-tube heating systems this is the mean design heating medium temperature of the last radiator in the line $t_{max,m}$: Highest mean design heating medium temperature at which the heat cost allocator may be used t_z : Mean heating medium temperature of the radiator at which the counter of the heat cost allocator starts up t_L : Reference air temperature t_m : Mean heating medium temperature	

Degree of protection	
Protection class	III as per EN 61140
Housing type	IP43 to EN 60529

Ambient conditions			
	Operation	Transportation	Storage
Temperature	5...70 °C	-25...+70 °C	-5...+45 °C
Humidity	<95% r.h. (non-condensing)		

Directives and standards	
Product standard	DIN EN 834 Heat cost allocator to acquire consumption data for room heating areas
EU conformity (CE)	See EU declaration of conformance *)
Environmental compatibility	The product environmental declaration *) contains data on environmentally compatible product design and assessments (RoHS compliance, material composition, packaging, environmental benefit, and disposal).

*) Documents can be downloaded at <https://www.siemens.com/bt/download>.

Material	
Dimensions	40 x 102 x 31 mm (W x H x D)
Sensor cable length	2.5 m
Weight	58 g
Housing material	ABS + PC
Housing colors	RAL 9016 traffic white

Dimensions

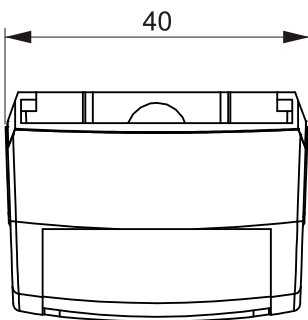
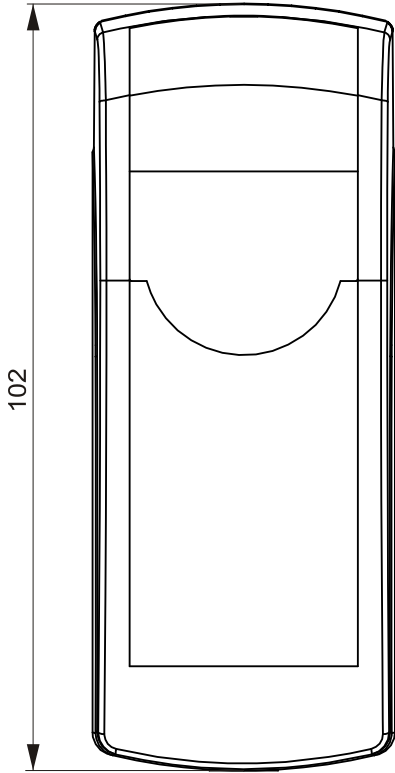
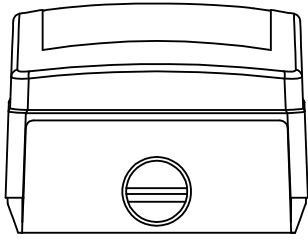

A6V_6229_M01

Issued by
Siemens Switzerland Ltd
Smart Infrastructure
Global Headquarters
Theilerstrasse 1a
CH-6300 Zug
+41 58 724 2424
www.siemens.com/buildingtechnologies

© Siemens 2016
Technical specifications and availability subject to change without notice.

Document ID A6V10786229_en--_h
Edition 2023-11-20